

Keeping Aviation Safe

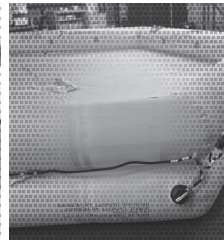
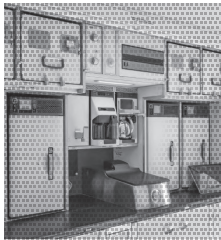
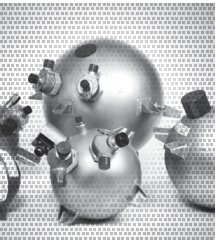

Aircraft Component MRO Services

Welcome to the SK AeroSafety Group

Knowledgeable, dependable, solutions driven

At SK AeroSafety Group, our commitment is clear: keeping aviation safe through proximity, turn around time & service. With facilities strategically located across Europe, North America, and Asia Pacific, we ensure industry-leading turnaround times that keep fleets flying and schedules on track.

Our purpose is simple—safety first. We achieve this through proactive maintenance, deep technical expertise, and a customer-first approach that puts your needs at the centre. Whether you're a global airline, regional carrier, or MRO partner, our proximity to major aviation hubs enables rapid response and seamless logistics support.

We take pride in delivering tailored solutions, backed by comprehensive certifications and OEM approvals. With an average group turnaround time of just 10 days and more than 80,000 jobs completed annually, our track record speaks for itself.

Through continuous investment in people, processes, and facilities, we maintain the highest standards of technical excellence. You can rely on us—around the clock—to deliver the dependable expertise that allows you to focus on your core business, knowing your operations are in safe hands.

Our Strength in Numbers

Global TAT 10 days

600 employees worldwide

€125m revenue in 2025

80,000 jobs completed annually

1 billion passengers kept safe

500,000+ spare parts in stock globally



Our People

Our Leadership Team



Tom McLaughlin
President / CEO Americas



Chris Wright
Chief Commercial Officer (CCO)



Ben te Beek
Group CEO



Matthijs Oehlen
Chief Financial Officer (CFO)



Dominik Wiener-Silva
President / CEO Europe

Tom has built a lifelong career in aviation, starting with major airlines before moving into MRO leadership. Since joining SK AeroSafety in 2024, he has been responsible for all business activities across the Americas, driving regional growth and strengthening customer partnerships through a commitment to operational excellence and service quality.

Chris joined SK AeroSafety in 2012 after serving in the Royal Air Force and establishing a successful career in commercial aerospace. With more than 34 years of industry experience, including founding and leading multiple aviation distribution and service companies, he now oversees the Group's global commercial strategy, sales, and customer partnerships, while fostering strong industry partnerships worldwide.

Ben joined SK AeroSafety in 2014 following eight years at Stork, where he held senior roles in both the Netherlands and the US. As Group CEO, he is responsible for leading the company's overall global strategy and performance, guiding the organisation through innovation, operational excellence, and customer-focused leadership to ensure sustainable growth worldwide.

Matthijs joined SK AeroSafety in 2025 as Group CFO, bringing extensive international expertise in finance, strategy, and operations. He is responsible for all financial management and global support functions, ensuring strong financial discipline and enabling the Group's long-term strategic growth and operational efficiency across all regions.

Dominik joined SK AeroSafety in 2025, bringing senior executive experience from leading airline groups including Lufthansa, Air France-KLM, and Singapore Airlines. With a proven global track record in strategy, operations, and MRO leadership, he is responsible for all business activities in Europe, ensuring results through operational excellence, customer focus, and a strong commitment to delivering value to aviation partners.

Our Purpose
Keeping aviation safe.

Our Vision
To be the best group of companies that specialise in the repair of safety and interior aircraft components for the global aviation market.

Our Mission
As One Team we deliver exceptional support to the aviation industry through a global network. Providing consistent quality, proximity, best-in-class turn around times and excellent service. Helping customers worldwide maintain safety and reliability at all times.

Our Products

The SK AeroSafety group provide maintenance, repair and overhaul services across the full spectrum of aircraft safety and interior equipment. Our safety capabilities include Oxygen cylinder, Oxygen Masks and stowage boxes, Fire extinguishers, Slides and Rafts as well as other safety components (i.e. life jackets, smoke hoods, emergency locator beacons, etc.). Our interior capabilities include Galley inserts, Cockpit security, (Crew) Seats & Restraints and Water & waste components. We have a number of OEM approvals with leading OEMs including Safran, BE Aerospace, Kidde/Hotelier, Eastern Aero Marine, Adams right, IPECO, ADOS and Liebherr. Select facilities also offer specialised capabilities in heat exchangers, electrical systems, starter generators and fuel and hydraulic components.

Our Services

To support our customers across the globe, we provide additional services that enhance and complete our offering:

Pick-up & Delivery – Free Efficient logistics to reduce downtime and cost.

Exchange & Rental Units – Immediate availability of safety-critical components.

MBM (Maintenance-by-Month) – transforms traditional repair models into a fixed monthly fee program

Inventory Management – Over 500,000 spare parts strategically stocked worldwide.

Digital Customer Access – Real-time job tracking, certification retrieval, and performance dashboards.

Specialised Sourcing – Strategic halon availability and OEM-backed support.

Our Global Locations

With 19 service centres across North America, Europe and APAC, SK AeroSafety Group provides truly global support. Strategically located near major aviation hubs, our facilities deliver fast, dependable turnaround times and seamless logistics, ensuring critical safety equipment is maintained and ready when needed.

Our global reach is strengthened by OEM approvals, international certifications, and a commitment to consistent service excellence. Wherever you operate, our network combines local expertise with worldwide standards—keeping aviation safe, reliable, and ready to fly.

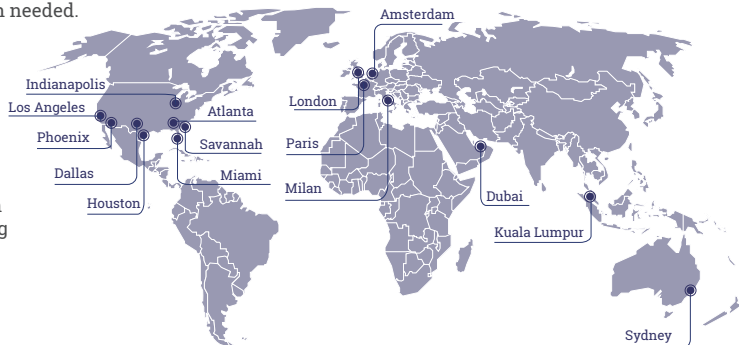

**SK AeroSafety®
Group**

Avia Technique
SK AeroSafety Group



Meridian
SK AeroSafety Group



Hugen MfA
SK AeroSafety Group



SafeTech
SK AeroSafety Group



Avia Technique Asia
SK AeroSafety Group



AeroTechnics Dubai
SK AeroSafety Group



Fire-Tec
SK AeroSafety Group



John Cameron Aviation
SK AeroSafety Group



EMS France
SK AeroSafety Group



AEOS Australia
SK AeroSafety Group



Reheat Aero
SK AeroSafety Group



Frontline
SK AeroSafety Group



Your nearest SK AeroSafety Facility

EUROPE

Avia Technique

Unit 1 Fishponds Estate, Fishponds Road,
Wokingham, Berkshire, RG41 2QJ, UK
Unit 1B, Tungsten park, Eastways, Witham,
Essex. CM8 3WG
T: +44 (0) 118 978 9789
F: +44 (0) 118 979 4511
E: sales@aviatechnique.co.uk
www.aviatechnique.co.uk

Meridian Technical Services Ltd

14 Hailey Road, Erith, Kent, DA18 4AP, UK
T: +44 (0) 208 3103911
E: sales@meridiantechservices.com
www.meridiantechservices.com

Reheat Aero

Riverside, Omega Park, Alton,
Hampshire GU34 2UFT
+44 (0) 1420 594000
E: sales@reheat.aero
www.reheat.aero

Hugen MFA

Marketing 43, 6921 RE Duiven,
The Netherlands
T: +31 (0) 26 303 3340
E: info@hugenmfa.com
www.hugenmfa.com

Frontline

Via Giacomo Puccini 5,
21021 Angera (VA), Italy
T: +39 0331 964226
E: info@frontline.it
www.frontline.it

EMS France

6 Rue Jean Monnet, 95190 Goussainville,
France
T: +33 01 39 88 63 55
E: info@ems-fr.aero
www.ems-fr.aero

ASIA PACIFIC

Aero Technics FZCO

Warehouse B16 & B17, Dubai International
Airport
Free Zone, Dubai, United Arab Emirates
T: + 971 4 299 1778
F: + 971 4 299 1779
E: info@aero-technics.com
www.skaerosafetygroup.com

Avia Technique Asia

No 4 Jalan Kerawang U8/108 Kawasan
Perindustrian Tekno Jelutong
Seksyen U8 40150 Shah Alam, Selangor
Malaysia
T: +603 7734 6347
F: +603 7734 4715
E: enquiry@aviatechnique.asia
www.skaerosafetygroup.com

John Cameron Aviation

Hangar/473 Birch St, Bankstown Aerodrome
NSW 2198, Australia
T: +61 2 9791 0155
E: engsupport@jcaaviation.com.au
www.jcaaviation.com.au

AEOS Australia

29 Norman Street, Peakhurst, Sydney, NSW,
Australia, 2210
T: +61 2 8525 6444
E: support@aeos.com.au
www.aeos.com.au

AMERICAS

SafeTech - Houston

1230 Wilson Road Court, Humble TX 77396
T: +1 (281) 446-1777
F: +1 (281) 446-2973
E: info@safetech-usa.com
www.safetech-usa.com

SafeTech - Miami

2891 NW 75th St, Miami, FL 33147
T: +1 (305) 693-8474
E: info@safetech-usa.com
www.safetech-usa.com

SafeTech - Indianapolis

5383 West 86th St., Indianapolis IN 46268
T: +1 (317) 243-1800
F: +1 (317) 243-8369
E: info@safetech-usa.com
www.safetech-usa.com

SafeTech - Atlanta

777 Wharton Dr, Atlanta, GA 30336
T: +1 (404) 699-1255
F: +1 (404) 699-1258
E: info@safetech-usa.com
www.safetech-usa.com

SafeTech - Savannah

58 Firefly Dr. Ridgeland, South Carolina, 29936
T: +1 (843) 547-1200
F: +1 (843) 547-12 06
E: info@safetech-usa.com
www.safetech-usa.com

SafeTech - Los Angeles

17907 Arenth Avenue City of Industry, CA 91748
T: +1 562-549-1875
E: info@safetech-usa.com
www.safetech-usa.com

SafeTech - Dallas

1625 Crescent Circle Drive, Suite 309, Carrollton
TX 75006
T: +1 (214)390-2792
E: info@safetech-usa.com

Fire-Tec Aero Systems

1936 W. Monona Dr., Phoenix, AZ 85027 USA
T: +1 (623) 580-8880
F: +1 (623) 580-8889
E: sales@fire-tecaero.com
www.fire-tecaero.com

Group Office

Office Operators
WTC Utrecht, Stadsplateau 7 3521 AZ Utrecht
E: enquiries@skaerosafetygroup.com
www.skaerosafetygroup.com

www.skaerosafetygroup.com

SK AEROSAFETY GROUP EUROPE

Our Capabilities and Reach

SK AeroSafety Group's European network combines specialised expertise with strategic locations near major aviation hubs. With facilities in the UK, France, Italy and the Netherlands, we deliver fast, reliable MRO services for safety and survival equipment, supported by OEM partnerships and global approvals.

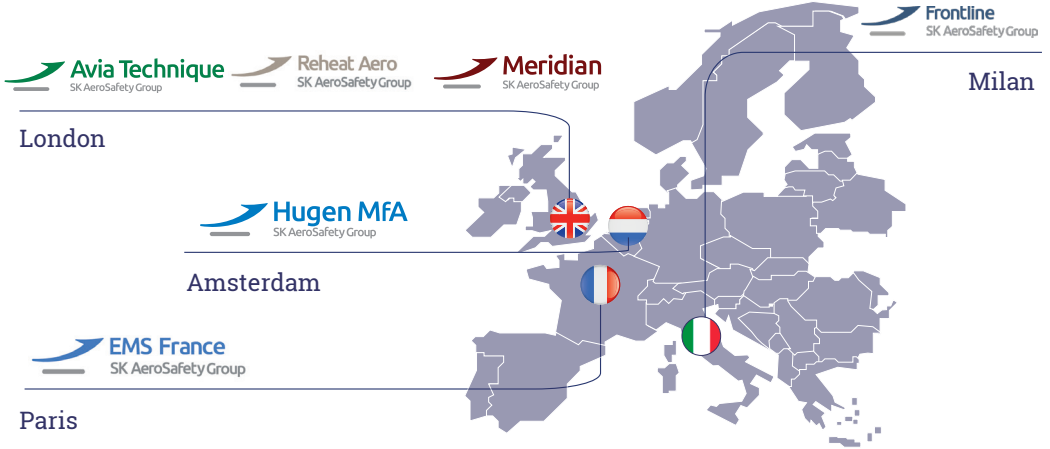

EUROPEAN PRODUCTS AND SERVICES



Life Jackets



Life Rafts



Oxygen Bottles



Fire Extinguishers



Fuel & Hydraulics

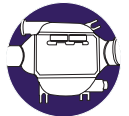

Heat Exchangers



Oxygen Masks



Smoke Hoods



Survival Kits



Beacons

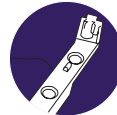

Electrical



Escape Slides



Galley Equipment



Water & Waste



Cockpit Security

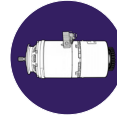

Starter Generators

EUROPEAN APPROVALS





Avia Technique

United Kingdom (Founded 2002)

Authorised repair centre for leading OEMs including Honeywell, Liebherr, and Parker. Operating from Wokingham and Witham—our centre of excellence for escape slides—we provide comprehensive MRO for safety and survival equipment, heat exchangers, filtration, and electrical components.

www.aviatechnique.co.uk



Reheat Aero

United Kingdom (Founded 1994)

Independent MRO and aftermarket provider specialising in the maintenance, repair, and overhaul of aircraft galley and interior equipment. With over 25 years of experience, Reheat supports airlines, OEMs, and MRO partners worldwide, offering comprehensive capability across ATA Chapters 25, 38 and 52 from its CAA, EASA, and FAA Part-145 approved repair station in the UK.

www.reheat.aero



EMS France

France (Founded 1990)

Located near Paris CDG and Le Bourget airports, EMS France specialises in safety and survival equipment repair with OEM-trained technicians. As an approved EAM distributor, we combine product expertise with efficient logistics and dedicated regional support.

www.ems-fr.aero



Hugen MFA

Netherlands (Founded 1982)

Serving Benelux-Germany with expertise in life jackets, oxygen, and slides. EASA, FAA, and DOT approved, supporting KLM, major airlines, MROs, and OEMs with dependable, high-quality service.

www.hugenmfa.com



Frontline

Milan (Founded 2007)

Located near Milan, Italy, Frontline is a specialised MRO for starter generators, searchlights, cargo hooks, and helicopter transmission components, holding EASA, UK CAA, FAA, and Italian Defence approvals.

www.frontline.it



SK AEROSAFETY GROUP ASIA PACIFIC

Asia Pacific – Our Capabilities and Reach

With facilities in Malaysia, the UAE, and Australia, SK AeroSafety Group delivers comprehensive safety and survival MRO support across the Asia Pacific region. Strategically located near major hubs, our centres provide specialised expertise, OEM-backed approvals, and efficient turnaround times for airlines and operators throughout the region.

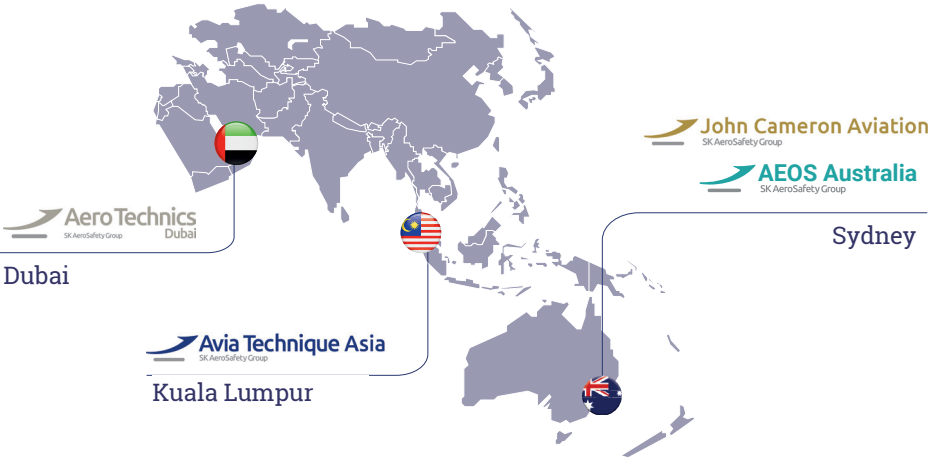

ASIA PACIFIC PRODUCTS AND SERVICES



ASIA PACIFIC APPROVALS





Avia Technique Asia

Malaysia (Founded 2013)

Operating from two purpose-built facilities near Subang Airport, Avia Technique Asia supports airlines across Asia with repair and overhaul services for safety and survival equipment. With more than a decade of operations, it holds long-term agreements with leading carriers across the region.

www.aviatechnique.co.uk

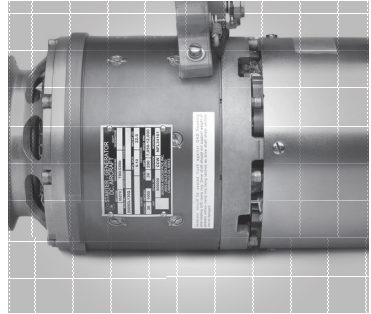

Aero Technics FZCO

UAE (Founded 2007)

Based in Dubai, Aero Technics provides inspection, repair, and overhaul services for safety and survival equipment, galley inserts, and interior components. Local pick-up and delivery enable rapid turnaround for regional customers, ensuring dependable service near one of the world's busiest aviation hubs.

www.skaerosafetygroup.com



John Cameron Aviation

Australia (Founded 1975)

An Airbus Approved Service Centre, John Cameron Aviation specialises in rotorcraft maintenance as well as oxygen, fire suppression, slides, and crew restraint systems. Serving both airlines and helicopter operators, the company has a long-standing reputation for safety and technical excellence in the region.

www.jcaviation.com.au



AEOS

Australia (Founded 1961)

AEOS is a family-owned company with deep expertise in regional aviation. Certified by EASA and CASA, it provides electrical, pneumatic, and hydraulic support, and is an authorised service centre for Honeywell and Collins. Its long heritage and strong technical capability make it a trusted partner for operators across Australia and beyond.

www.aeos.com.au

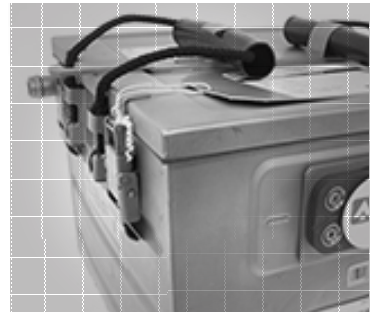

SK AEROSAFETY GROUP NORTH AMERICA

North America – Our Capabilities and Reach

SK AeroSafety Group operates one of the largest safety MRO networks in North America, with facilities across the United States strategically positioned near key aviation hubs. Our centres combine local expertise with global standards to deliver reliable, certified repair and overhaul services that keep fleets flying safely and efficiently.

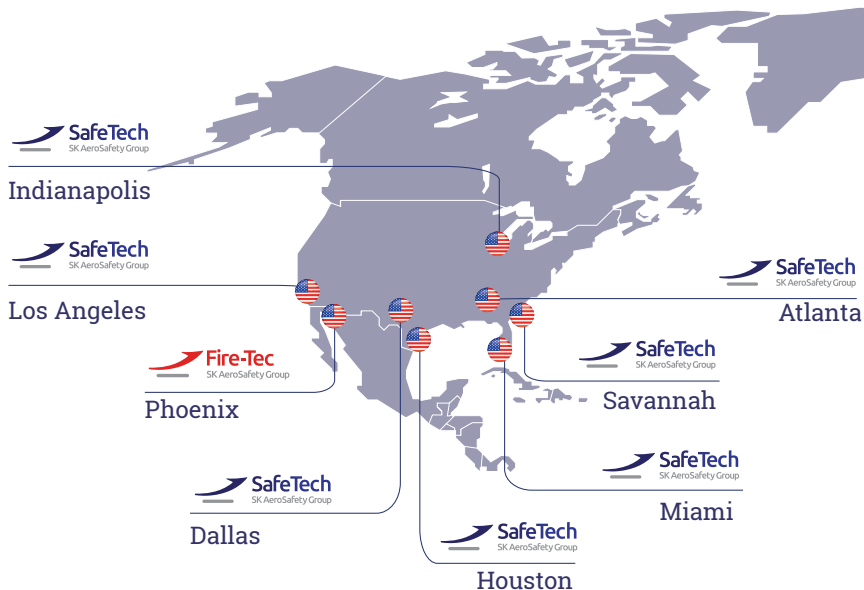

NORTH AMERICA PRODUCTS AND SERVICES



Life Jackets



Life Rafts



Oxygen Bottles



Smoke Hoods



Vacuum Generator



Oxygen Masks



Escape Slides



Fire Extinguishers



Survival Kits

NORTH AMERICA APPROVALS





SafeTech - United States (Founded 1984)

With facilities in Houston, Dallas, Atlanta, Miami, Indianapolis, Savannah, and Los Angeles, SafeTech is a market leader in aviation safety MRO. Trusted by airlines, OEMs, and private operators, SafeTech provides extensive support for life rafts, slides, life vests, and more, with approvals from leading OEMs including EAM and Switlik.

www.safetech-usa.com



Fire-Tec Aero Systems - United States (Founded 2005)

Based in Phoenix, Fire-Tec Aero Systems specialises in cargo, engine, and APU fire extinguishers, handheld extinguishers, emergency power reservoirs, and oxygen bottles. Certified by FAA, EASA, and DOT, Fire-Tec combines MRO services with global supply, ensuring superior service and rapid turnaround times.

www.fire-tecaero.com



SK AEROSAFETY GROUP SPECIAL SERVICES



Meridian Technical Services

United Kingdom (Founded 1998)

Specialist in fire suppression systems and halon recovery, recycling, and storage. ISO, DOT, and Environment Agency approved for trusted sourcing and compliant waste management.

www.meridiantechservices.com

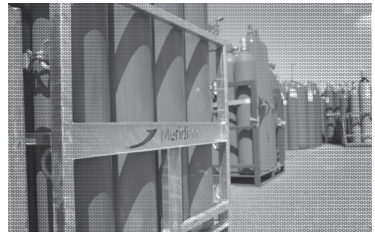

Keeping Aviation Safe

